

Клуб робототехников / Лего / Ардуино / Уроки

# Джип

*(модель без  
смартхаба)*

*WeDo2.0*



[t.me/robototekhnik](https://t.me/robototekhnik)

<https://vk.com/clubrobototekhnikov>

1

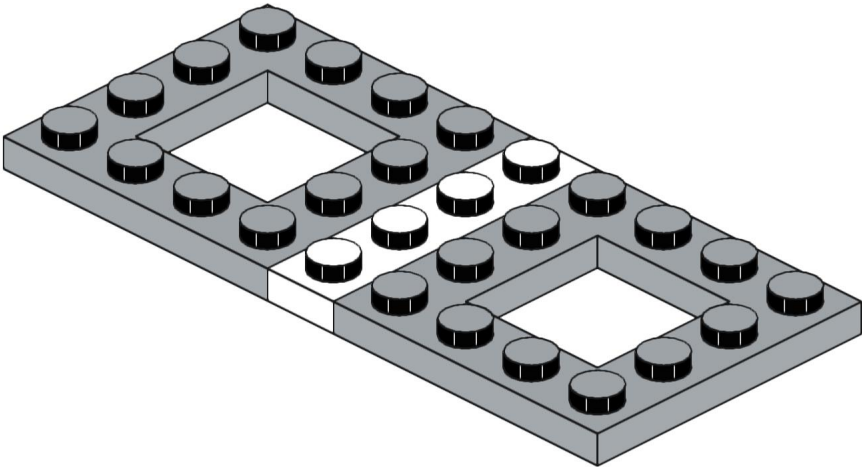
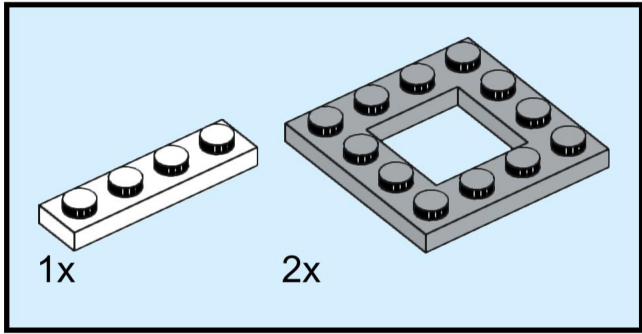

2

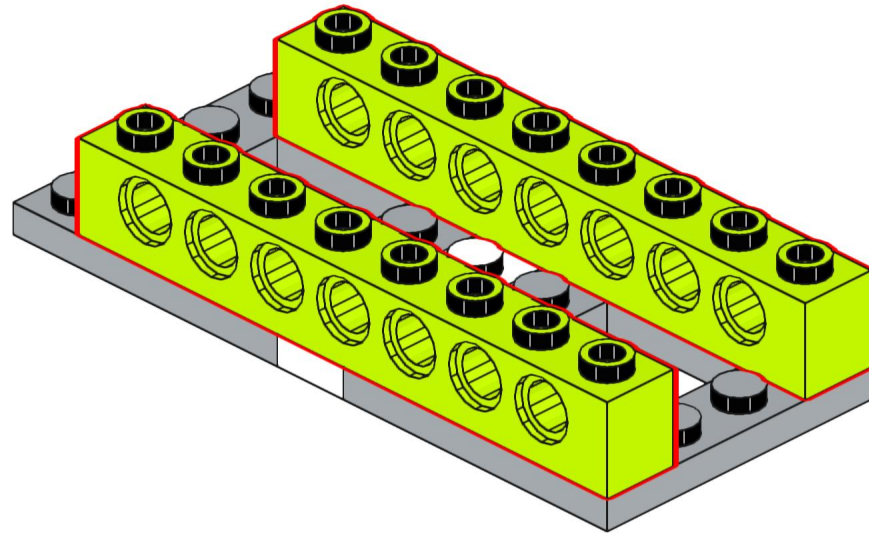
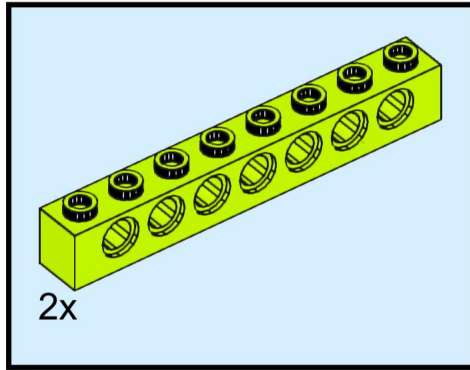

3

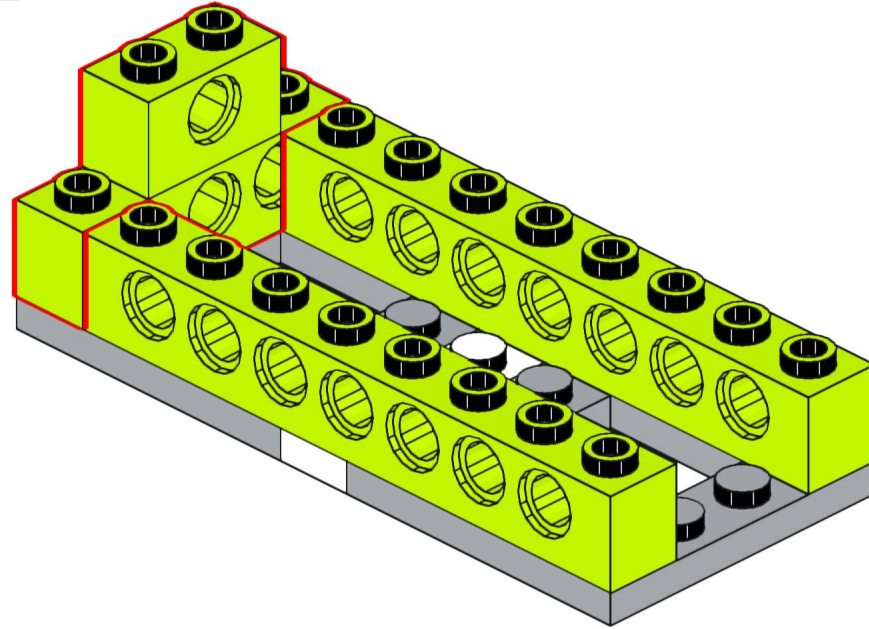
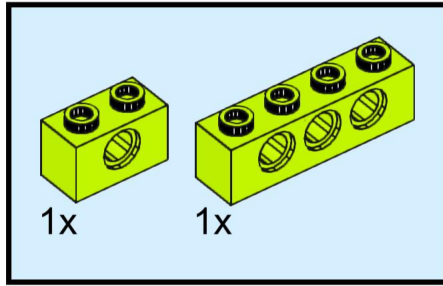

4

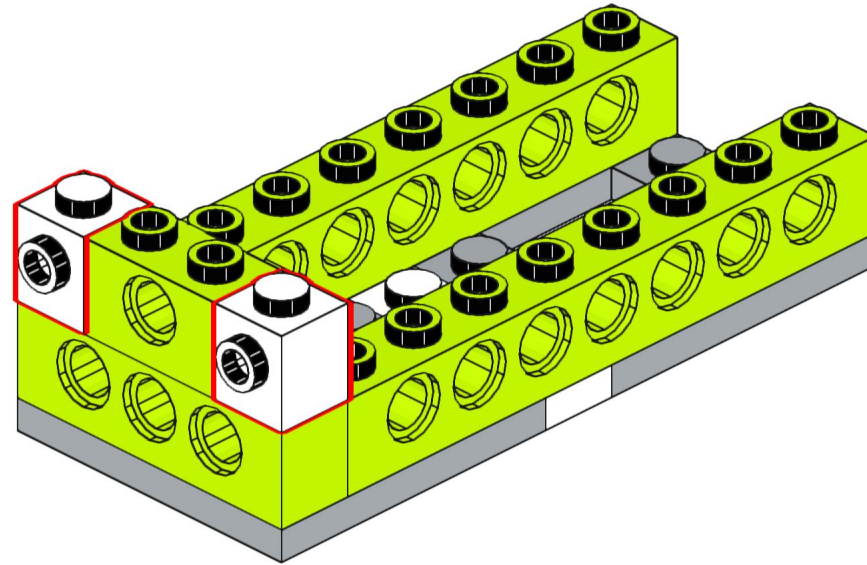
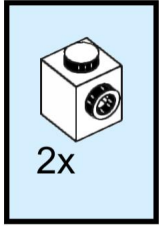

5

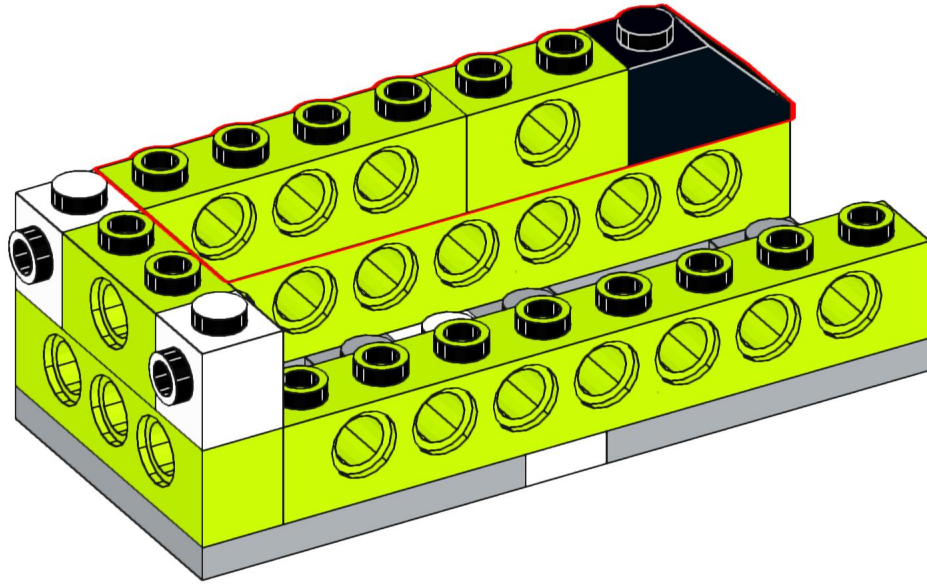
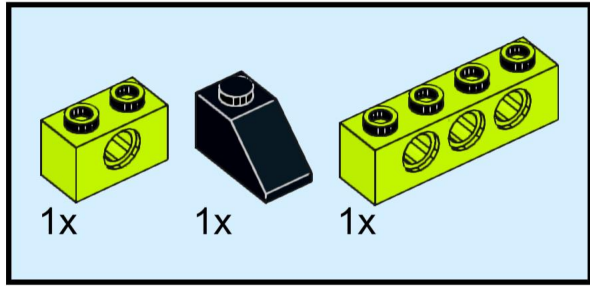

6

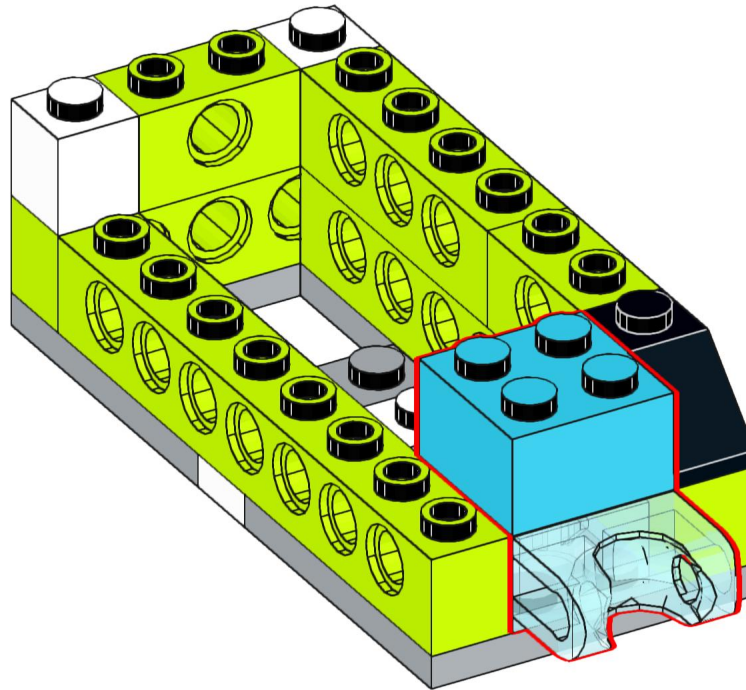
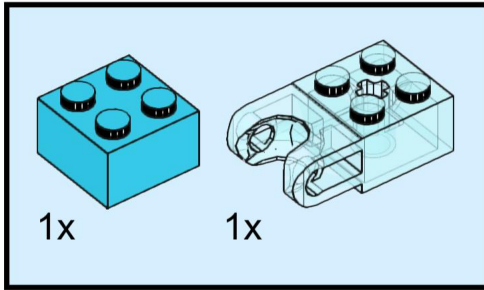

7

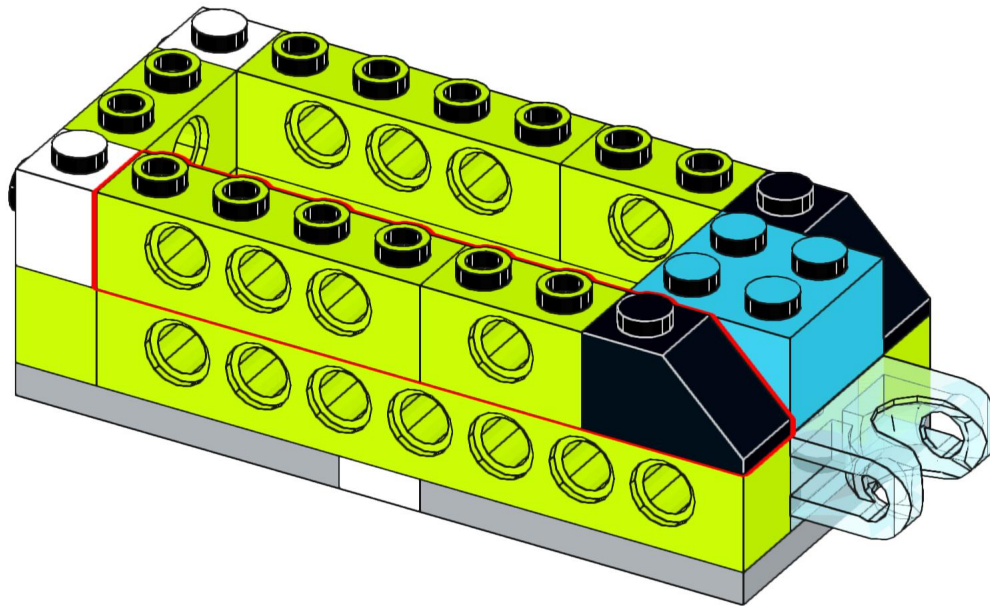
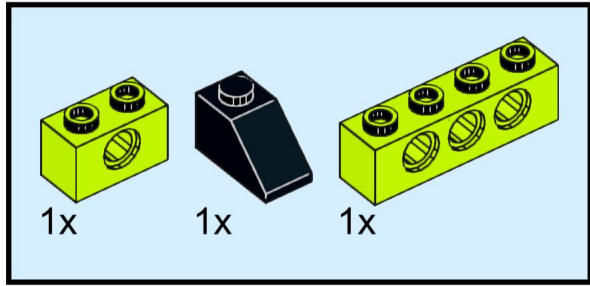



8

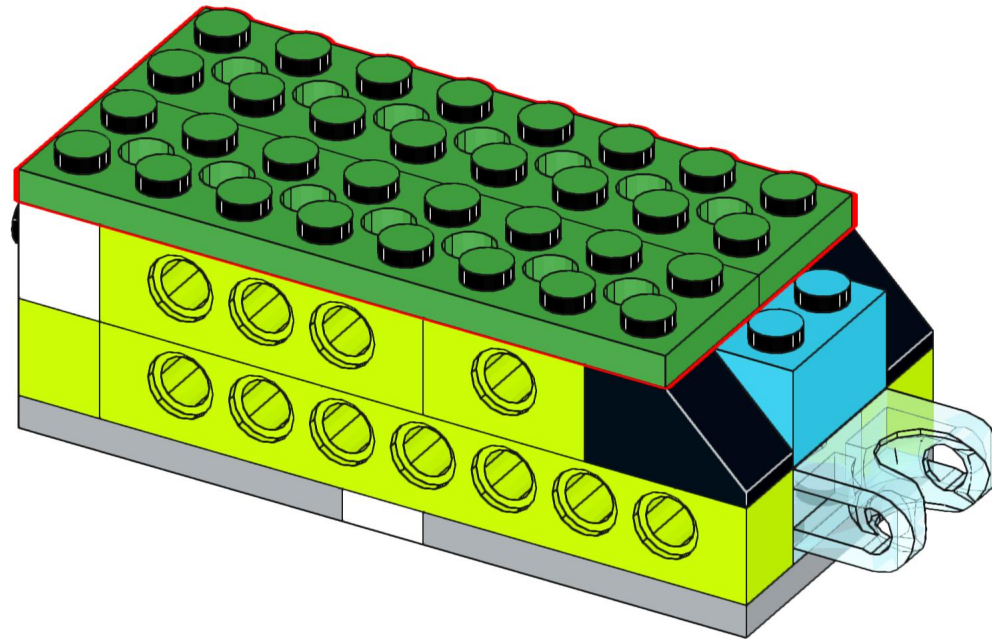
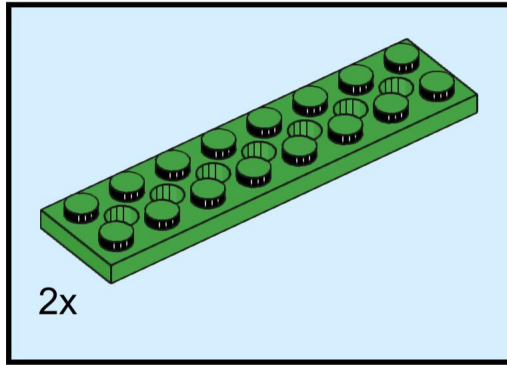

9

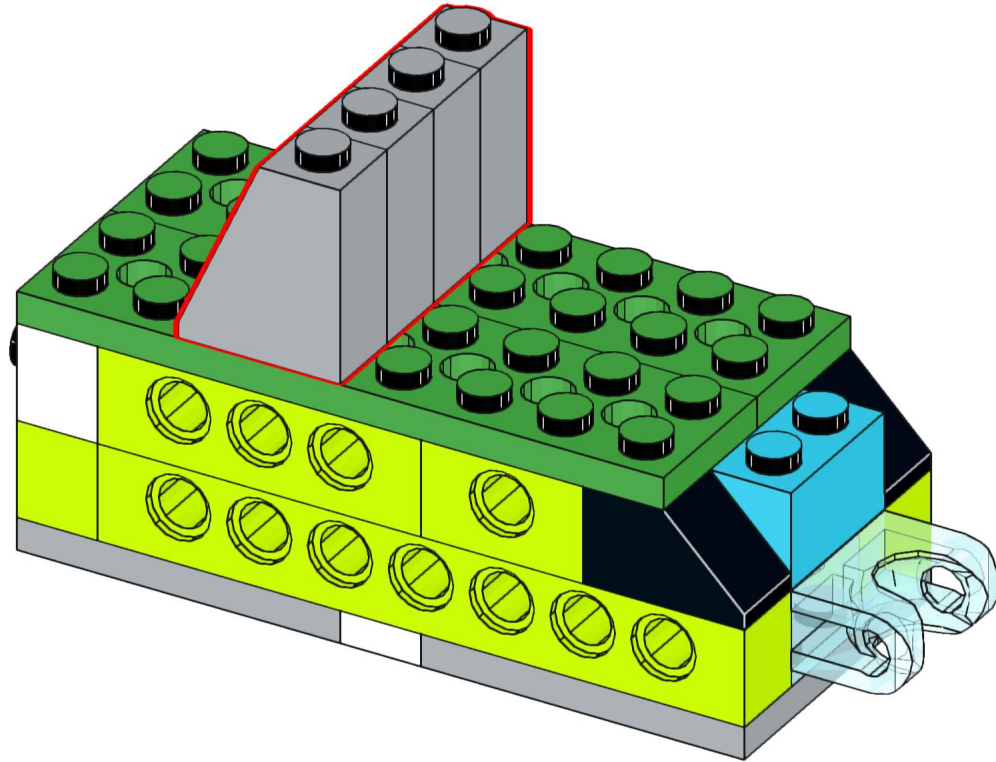
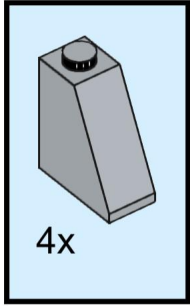

# 10

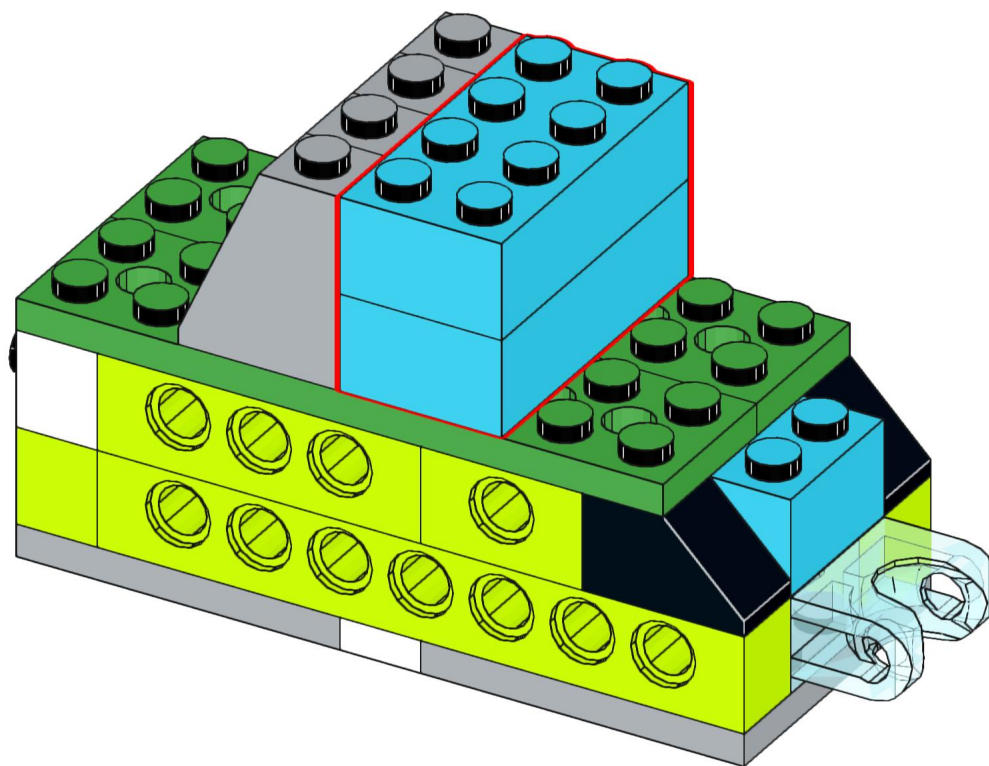
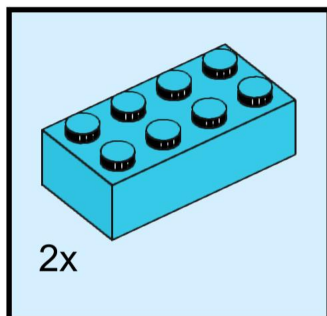

# 11

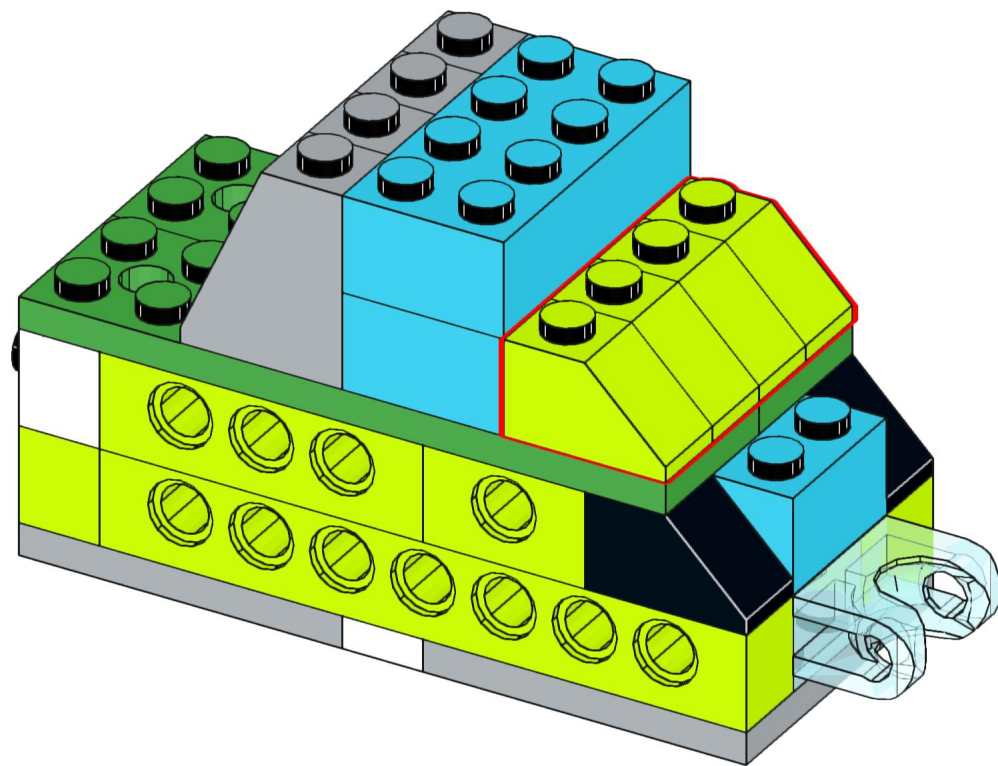
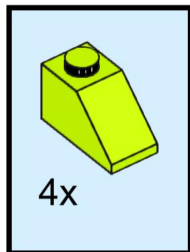

# 12

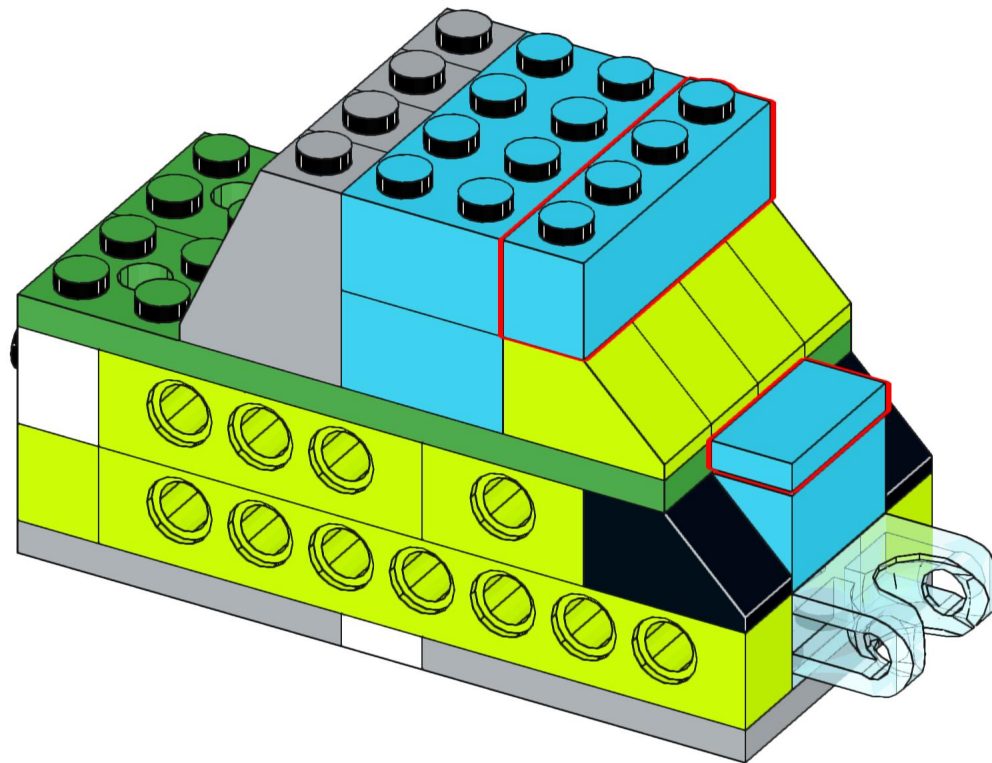
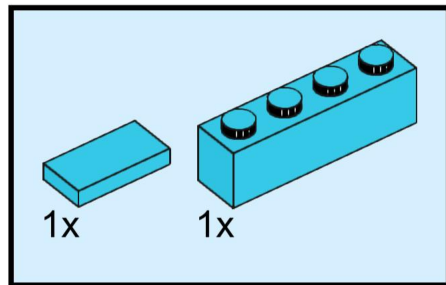

# 13

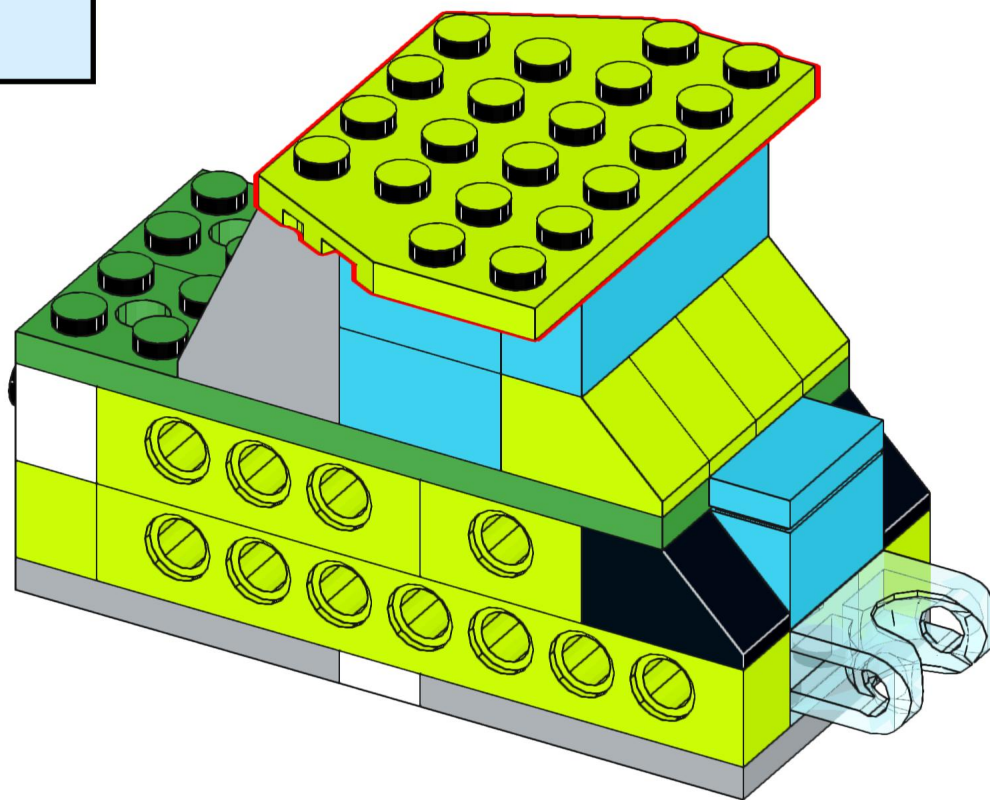
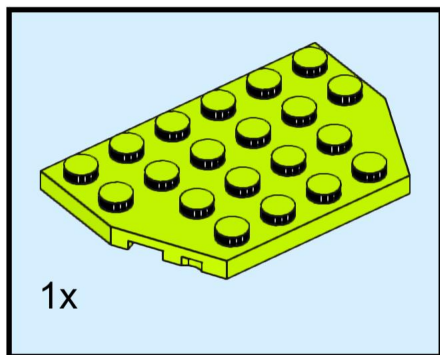

# 14

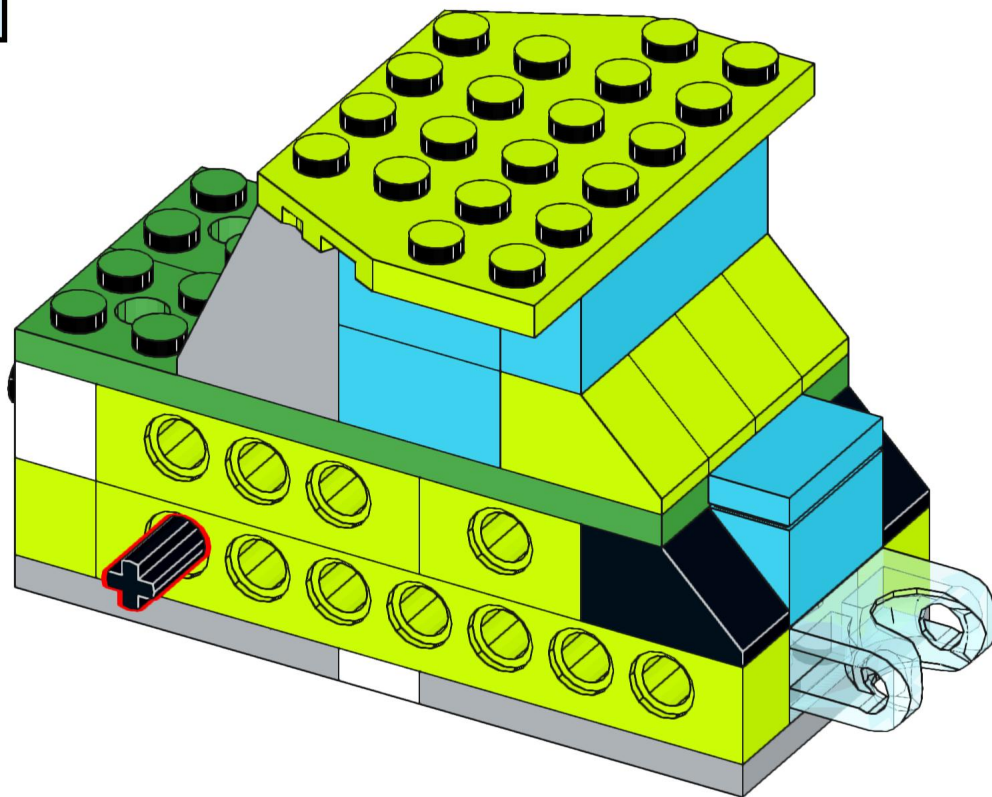
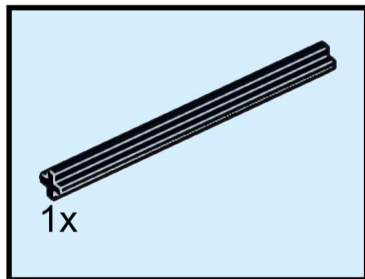

# 15

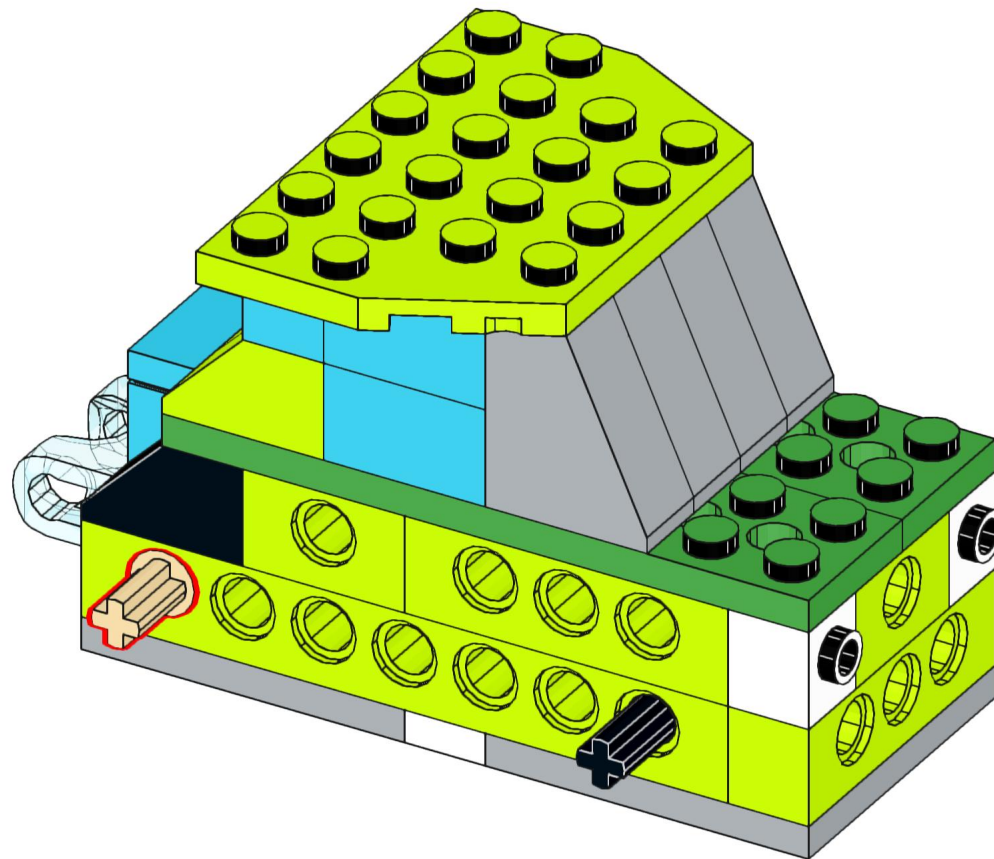
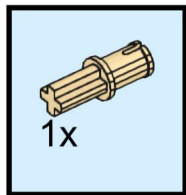



# 16

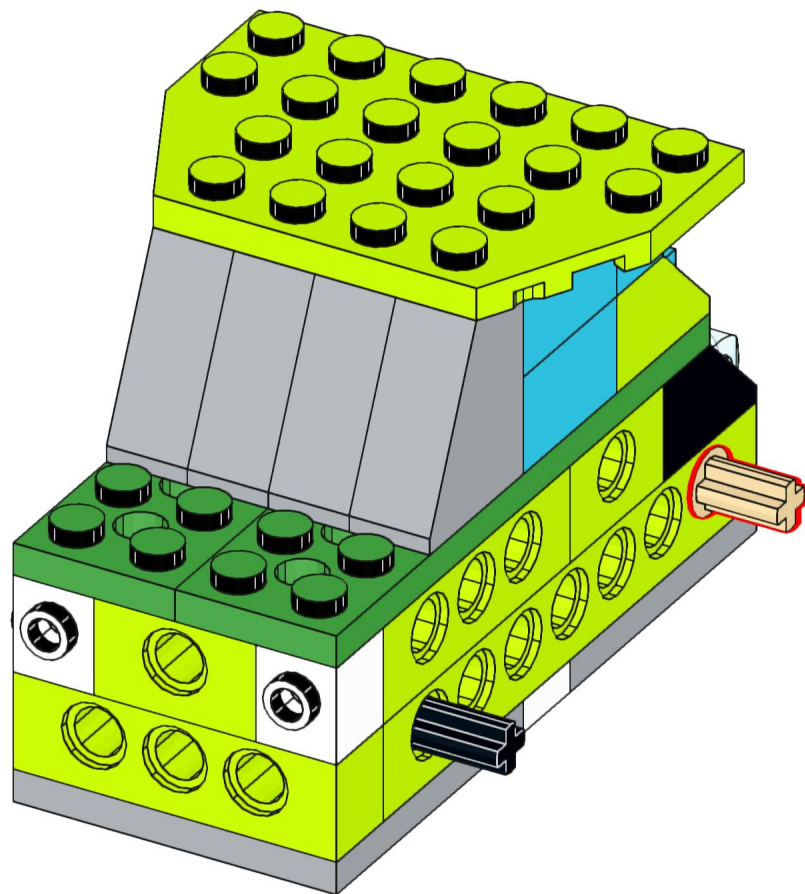
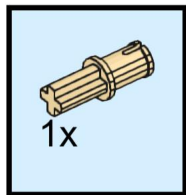

# 17

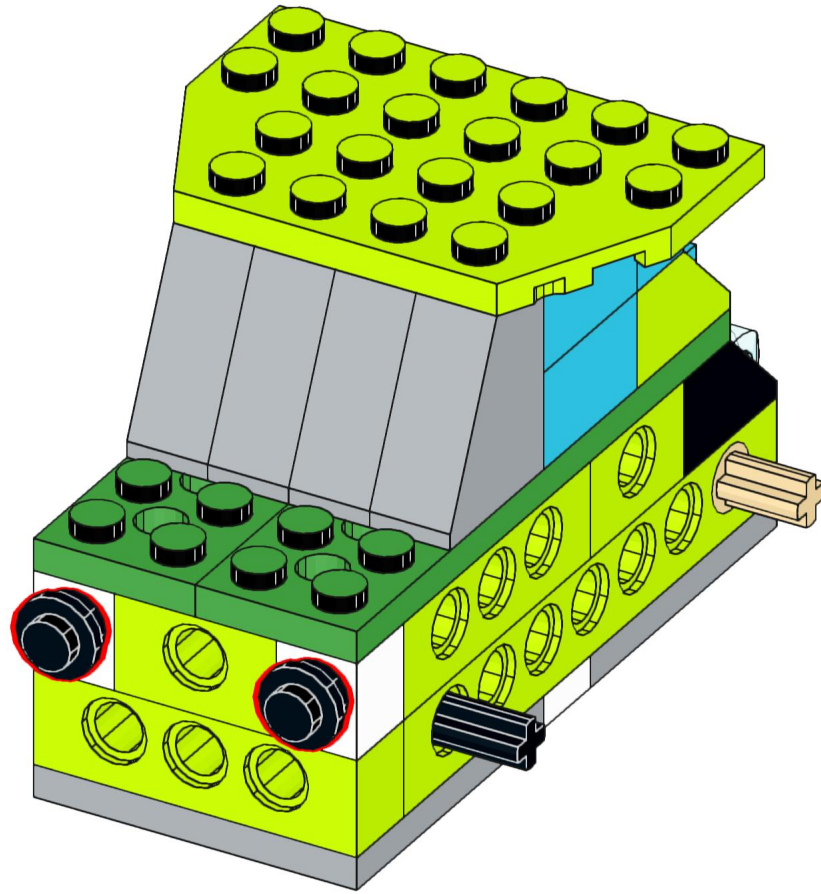
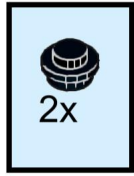

# 18

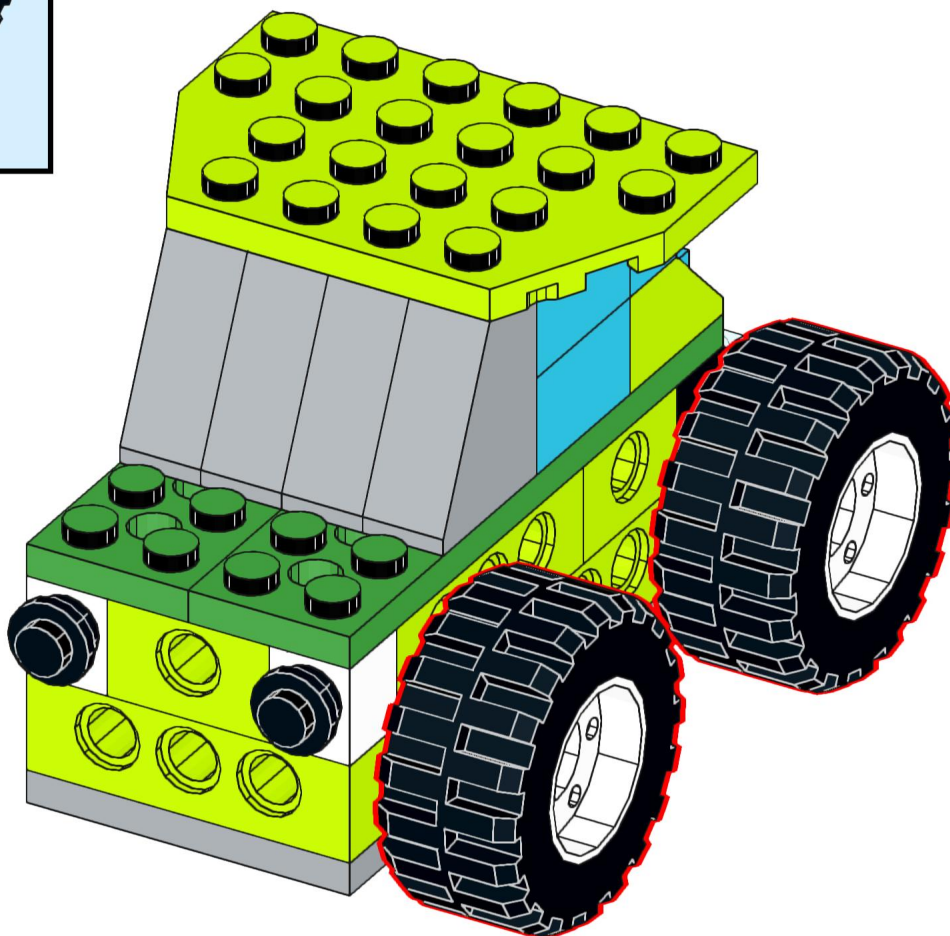
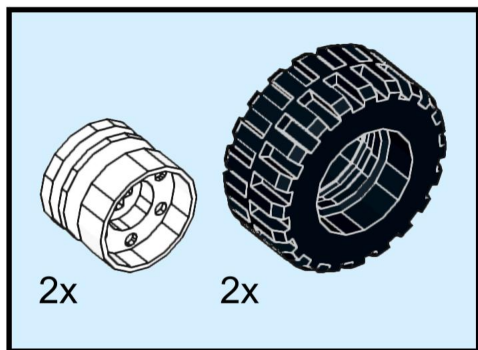

# 19

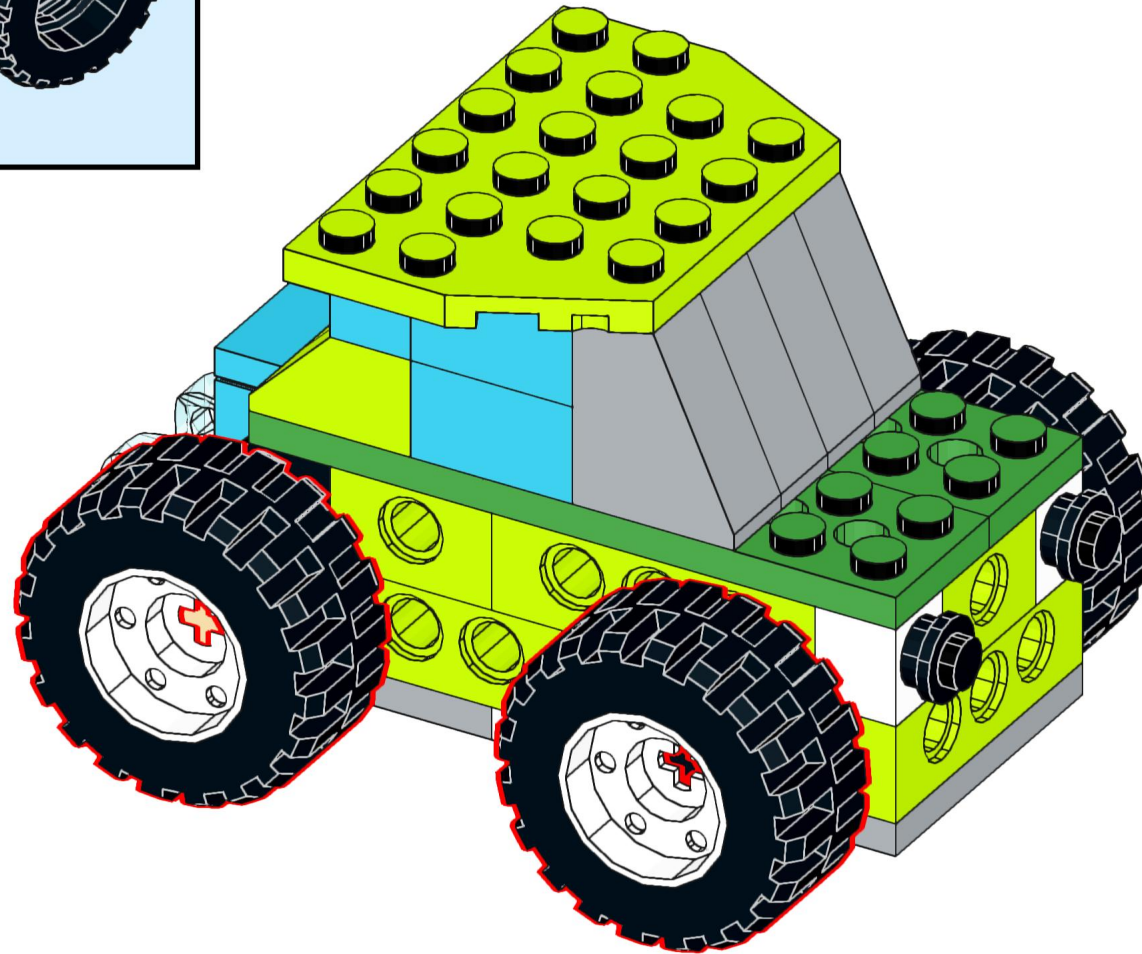
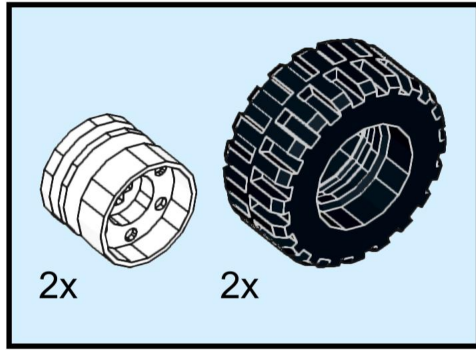

20

